

Symbolbild







## Datenblatt

**Artikelnummer:** 70010222

**Bezeichnung:** KG20A.T904.VE2

**Beschreibung:** Schalter lokaler Trenner

IEC 60947-3 EN 60947-3, VDE 0660 Teil 107						
<b>Bemessungsisolationsspannung Ui</b>						
<i>Spannung (V) AC / DC</i>						
690 AC						
<b>Bemessungsdauerstrom Iu/Ith</b>						
<i>Strom (A)</i>	<i>Umgebungstemperatur (°C)</i>	<i>Temperaturspitzen (°C)</i>	<i>zusätzliche Bedingungen</i>			
25	50	55	Umgebungstemperatur +50°C über 24 Stunden mit Spitzen bis +55°C			
<b>Bemessungsbetriebsstrom Ie</b>						
<i>Spannung (V)</i>						
<i>Gebrauchskategorie</i>						<i>Strom (A)</i>
AC-32A						20 - 400
<b>Bemessungsbetriebsleistung</b>						
<i>Spannung (V)</i>						
<i>Phasenanzahl</i>						
<i>Polanzahl</i>						
<i>Leistung (kW)</i>						
<i>Gebrauchskategorie</i>						
AC-3	220 - 240	3	3	3	4	
AC-3	380 - 440	3	3	3	5,50	
AC-3	660 - 690	3	3	3	5,50	
AC-23A	220 - 240	3	3	3	5,50	
AC-23A	380 - 440	3	3	3	7,50	
AC-23A	660 - 690	3	3	3	7,50	
<b>Max. Sicherungsnennstrom IEC</b>						
<i>Sicherungscharakteristik</i>						
<i>gG</i>						<i>Sicherungsanzahl</i>
						<i>Strom (A)</i>
						1
						35
<b>UL60947-4-1, UL508</b>						
<b>Nominal Voltage</b>						
<i>Spannung (V) AC / DC</i>						
600 AC						
<b>Bemessungsisolationsspannung Ui</b>						
<i>Spannung (V) AC / DC</i>						
600 AC						
<b>Rated thermal current</b>						
<i>Strom (A)</i>						
<i>Umgebungstemperatur (°C)</i>						
<i>Zusatz Text</i>						
25						
0 - 40 -						
<b>Horsepower rating</b>						
<i>Spannung (V)</i>						
<i>Phasenanzahl</i>						
<i>Polanzahl</i>						
<i>Leistung (HP)</i>						
<i>Umgebungstemperatur [°C]</i>						
<i>Across-the-Line Motor Starting</i>						
DOL	110 - 120	1	2	1	40	
DOL	220 - 240	1	2	3	40	
DOL	277 - 277	1	2	3	40	
DOL	415 - 415	1	2	5	40	
DOL	440 - 480	1	2	5	40	
DOL	550 - 600	1	2	5	40	
DOL	110 - 120	3	3	2	40	
DOL	200 - 240	3	3	7,50	40	
DOL	415 - 415	3	3	10	40	
DOL	440 - 480	3	3	15	40	
DOL	550 - 600	3	3	20	40	
<b>Pilot duty rating code</b>						
<i>Duty Code</i>						
A600						
<b>SCCR / Max. Vorsicherung</b>						
<i>Conditions of acceptability</i>						
This device is suitable for use on circuits capable of delivering not more than 10kA rms symmetrical amperes, 600V ac max. when protected by Type RK1 fuses.						
Suitable for use on a circuit capable of delivering not more than 65000 rms symmetrical amperes at 600V max., when protected by 40A Class J fuses.						
<b>Temp. rating of wire</b>						
<i>Temperature Rating (°C)</i>						
60 - 75						
<i>Strom (A) Text</i>						
-- --						
<b>General Use</b>						
<i>AC / DC</i>	<i>Spannung (V)</i>	<i>Strom (A)</i>	<i>Phasenanzahl</i>	<i>Polanzahl</i>	<i>Anzahl der Kontakte in Serie</i>	
AC	277	25	1	1	1	
AC	600	25	1	2	1	
AC	600	25	3	3	1	
<b>Allgemeine Informationen</b>						
<i>Text</i>						
- The operating handle and position indicating means to be used with these manual motor controllers should be provided from the manufacturer, or the operating handle and position indicating means to be used should have been previously evaluated in combination with the manual motor controllers.						

Allgemeine Informationen						
Text						
- When intended for use as a motor disconnecter the device shall be provided with a method of being locked in the OFF-position.						
CSA						
Nominal Voltage						
		Spannung (V) AC / DC				
		600 AC				
Bemessungsisolationsspannung Ui						
		Spannung (V) AC / DC				
		600 AC				
Rated thermal current						
		Strom (A)	Umgebungstemperatur (°C)			Zusatz Text
		25	0 - 40			-
Horsepower rating						
Across-the-Line Motor Starting						
		Spannung (V)	Phasenzahl	Polanzahl	Leistung (HP)	Umgebungstemperatur [°C]
DOL		110 - 120	1	2	1	40
DOL		220 - 240	1	2	3	40
DOL		277 - 277	1	2	3	40
DOL		415 - 415	1	2	5	40
DOL		440 - 480	1	2	5	40
DOL		550 - 600	1	2	5	40
DOL		110 - 120	3	3	2	40
DOL		220 - 240	3	3	7,50	40
DOL		415 - 415	3	3	10	40
DOL		440 - 480	3	3	15	40
DOL		550 - 600	3	3	20	40
Pilot duty rating code						
Duty Code						
A600						
Temp. rating of wire						
		Temperature Rating (°C)	Strom (A) Text			
		75	-- --			
General Use						
AC / DC	Spannung (V)	Strom (A)	Phasenzahl	Polanzahl	Anzahl der Kontakte in Serie	
AC	277	25	1	1	1	
AC	600	25	1	2	1	
AC	600	25	3	3	1	
GENERAL TECHNICAL INFORMATION						
Leiterquerschnitt						
Leiteraufbau	Min. / Max. Wert	Anzahl der Leiter pro Klemme		Drahtquerschnitt (-bereich) (mm <sup>2</sup> ) oder (AWG/kcmil)		Drahtmaterial
feindrätig	Max.	1		1 AWG 10		Kupfer
feindrätig	Max.	1		4mm <sup>2</sup>		Kupfer
ein- bzw. mehrdrätig	Max.	1		6mm <sup>2</sup>		Kupfer
ein- bzw. mehrdrätig	Max.	1		AWG 10		Kupfer
feindrätig mit Hülse	Max.	1		4mm <sup>2</sup>		Kupfer
Abisolierlänge des Leiters						
		Länge (mm)	Anschlusslänge - Bild			
		9				
Empfohlene Schraubendreher						
Schraubendreherart			Wert			
Kreuzschlitz - Schraubendreher			PH2			
Schlitzschraubendreher nach DIN 5264			0,8x4			
Klemmschraube						
		Anzugsdrehmoment (Nm)			Anzugsdrehmoment (lb-in)	
		1,25			11	
Approbationen						
Specification					Marking	
EAC						
CE marking						
UK Directives						
CSA C.22.2 No.14						
GB/T14048.3						
Allgemeine Informationen						
Text						
- EMV Hinweis: Dieses Gerät ist für den Einsatz in Umgebung A und B geeignet.						
- Die Schaltgeräte sind wartungsfrei. Schmierung oder Behandlung von Kontakten ist zu unterlassen.						
- Die Schalter dürfen nur von Fachkräften und nach den anerkannten Regeln der Technik eingebaut, angeschlossen und in Betrieb genommen werden.						

## Allgemeine Informationen

### Text

- Nur Kupferleitungen verwenden. Leiterenden nicht verzinnen.

- Klemmen mit werksseitig angeschlossenen Verbindungslaschen bzw. Drahtverbindungen werden verschraubt geliefert. Nach dem Öffnen solcher Klemmen ist darauf zu achten, dass keine Verbindungslaschen verloren gehen, alle Drahtverbindungen wieder korrekt sitzen und die Klemmschrauben mit dem angegebenen Drehmoment wieder festgezogen werden.

### Waste Electrical & Electronic Equipment (WEEE)

#### Picture name

#### Description



Nicht in den Müll werfen, da auf eine umweltgerechte Entsorgung und Wiederverwertung geachtet werden muss. Bitte wenden Sie sich entweder an ein umweltfreundliches Entsorgungsunternehmen; senden Sie es zur Entsorgung an den Lieferanten oder direkt an den Hersteller Kraus & Naimer zurück. Lokale Kraus & Naimer Ansprechpartner finden Sie unter [www.krausnaimer.com](http://www.krausnaimer.com)

### Proposition 65

#### Bildname

#### Beschreibung



WARNING: This product can expose you to chemicals including nickel and lead, which is known to the State of California to cause cancer. For more information go to [www.P65Warnings.ca.gov](http://www.P65Warnings.ca.gov).

Kontakttype: Starre Kontaktbrücke

Kontaktmaterial: Silber

Anschluss: Schraubanschluss

## Bauform-VE2

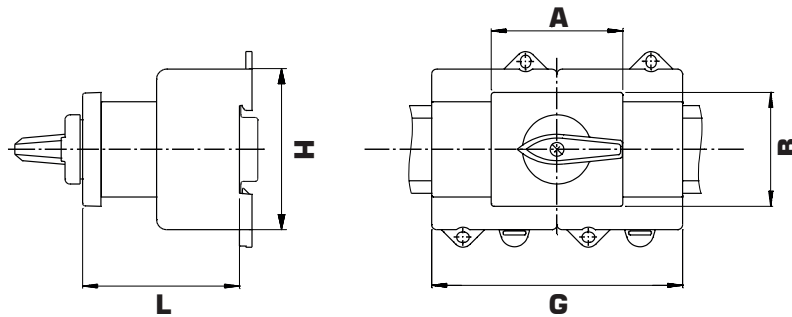

IP - Schutzart Front		IP20
Fluchten		8,00 - 12,00
A	H	43,70 mm
B	H	45,40 mm
G	H	111,00 mm
H	H	54,00 mm
L	H	64,00 mm

## Anschlussbild

KG20A.T904.VE2

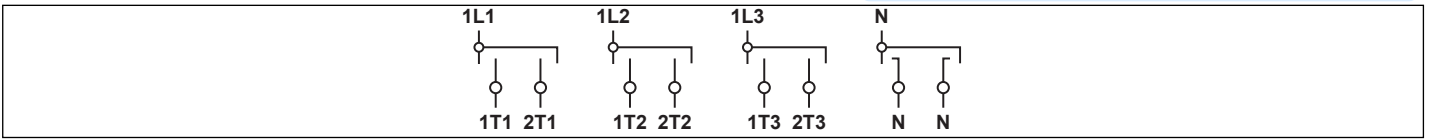

# Schaltprogramm

KG20A.T904.VE2

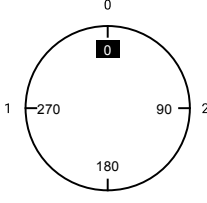
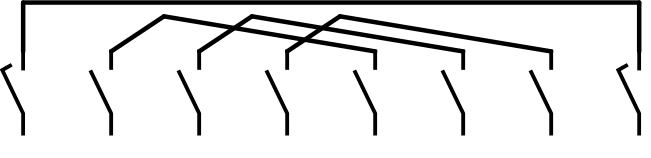
Frontschild		KG20A		T904			Seite 1 von 1		
		N	1L1	1L2	1L3	2L1	2L2	2L3	N
		1	3	5	7	9	11	13	15
									
Schaltwinkel	90	2	4	6	8	10	12	14	16
Gesamtschaltwinkel	180	N	1T1	1T2	1T3	2T1	2T2	2T3	N
1	270	█	█	█	█				
0	0								
2	90					█	█	█	█
	180								

Version: 224

**Frontschild**

K0.F057/C10.VE2

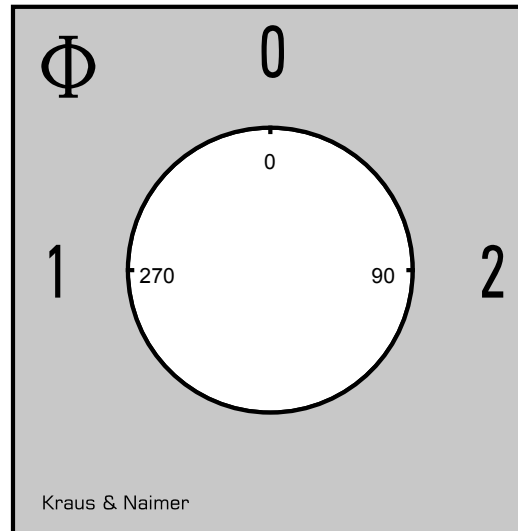

## GRIFFE

**Bezeichnung:** S0C.G227

**Grifffarbe:** "7" elektro grau

